

ARTIC

DESIGN Cristian Feltrin



vetro pulegoso
pulegoso glass



vetro martellato
hammered glass

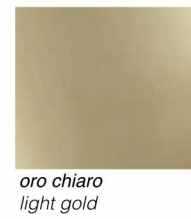

oro chiaro
light gold

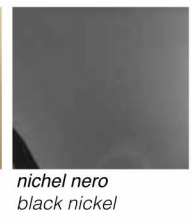

nichel nero
black nickel



pure steel
pure steel

Il telaio in metallo è disponibile nelle seguenti finiture:
- oro chiaro
- nichel nero
- pure steel

Metal frame is available in the following finishes:
- light gold
- black nickel
- pure steel

Vetro di Murano trasparente pulegoso e martellato abbinato con lame in metallo oro chiaro, nichel nero o pure steel.

Pulegoso or hammered transparent Murano glass with light gold, black nickel or pure steel metal blades.

SOSPENSIONE SUSPENSION

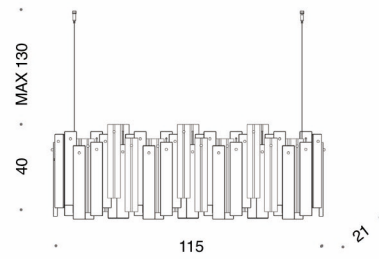

642/115
10 x LED 3,6W
3850 lumen - 3000 K
CE ⊕ ▽

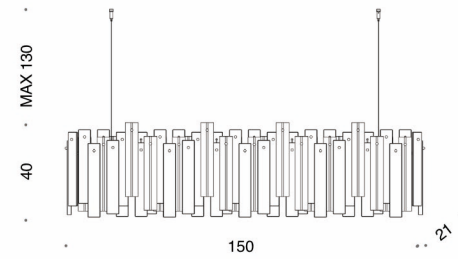

642/150
14 x LED 3,6W
5390 lumen - 3000 K
CE ⊕ ▽

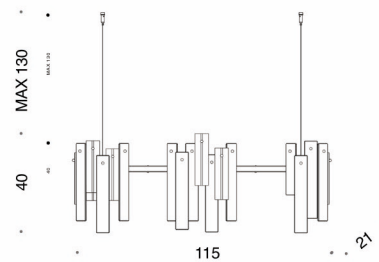

643/10
8 x LED 3,6W
3080 lumen - 3000 K
CE ⊕ ▽

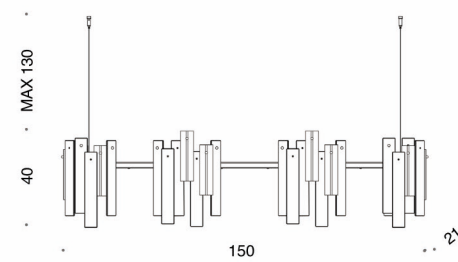

643/12
12 x LED 3,6W
4620 lumen - 3000 K
CE ⊕ ▽

SOSPENSIONE SUSPENSION

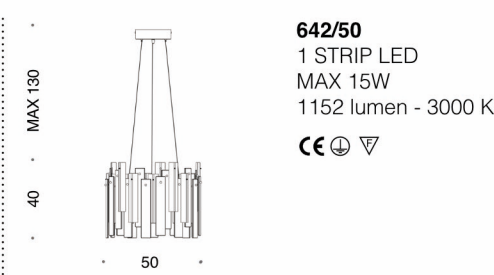

642/50
1 STRIP LED
MAX 15W
1152 lumen - 3000 K
CE ⊕ ▽

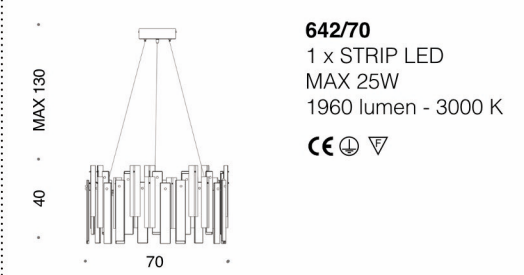

642/70
1 x STRIP LED
MAX 25W
1960 lumen - 3000 K
CE ⊕ ▽

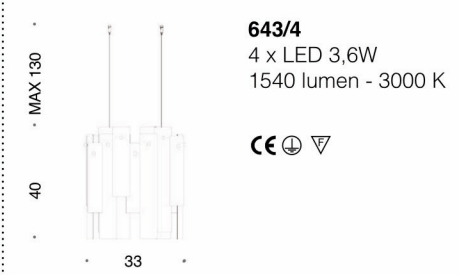

643/4
4 x LED 3,6W
1540 lumen - 3000 K
CE ⊕ ▽

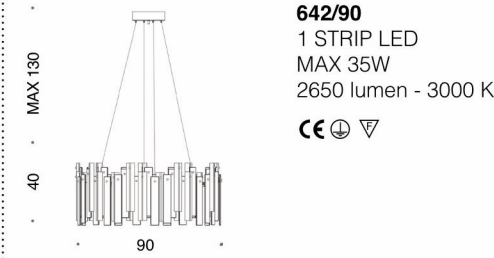

642/90
1 STRIP LED
MAX 35W
2650 lumen - 3000 K
CE ⊕ ▽

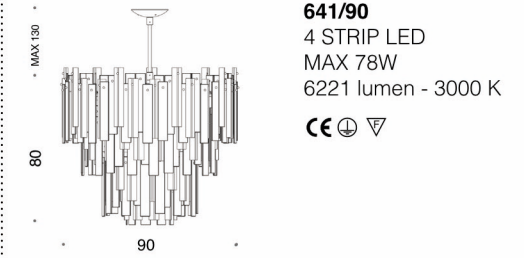

641/90
4 STRIP LED
MAX 78W
6221 lumen - 3000 K
CE ⊕ ▽

PLAFONIERA CEILING LAMP

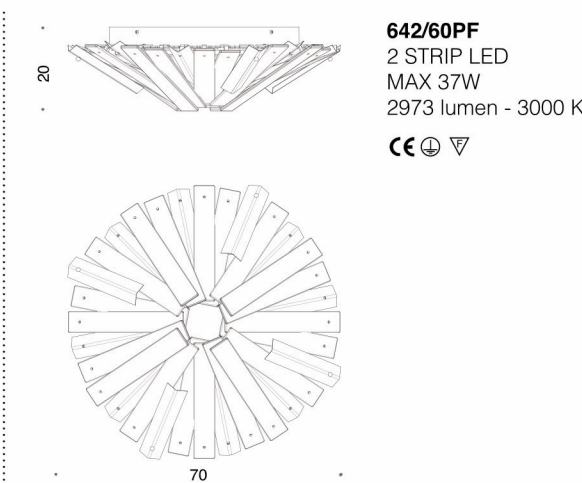

642/60PF
2 STRIP LED
MAX 37W
2973 lumen - 3000 K
CE ⊕ ▽

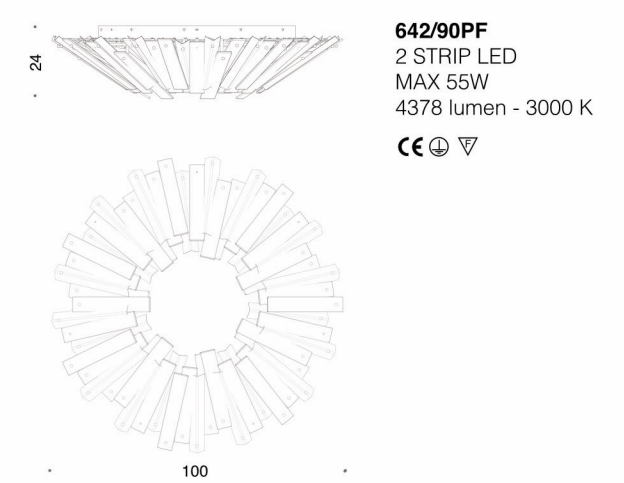

642/90PF
2 STRIP LED
MAX 55W
4378 lumen - 3000 K
CE ⊕ ▽

APPLIQUE WALL BRACKET

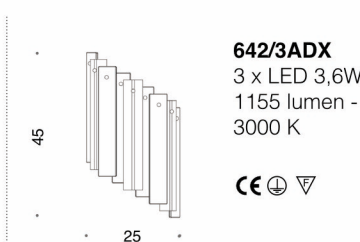

642/3ADX
3 x LED 3,6W
1155 lumen - 3000 K
CE ⊕ ▽

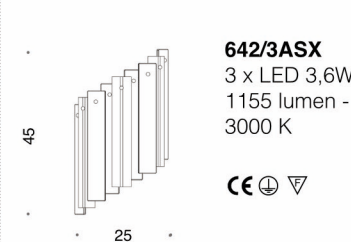

642/3ASX
3 x LED 3,6W
1155 lumen - 3000 K
CE ⊕ ▽

LAMPADA DA TAVOLO TABLE LAMP



642/L
1 STRIP LED
MAX 9,2W
660 lumen - 3000 K
CE ⊕ ▽